



Evacuation road direction - Surface Mounted

SURFACE MOUNTED/RECESSED

Guarantees excellent visibility of the sign through the application of advanced lighting technology solutions and special materials with high translucent characteristics.

APPLICATION

Evacuation road direction

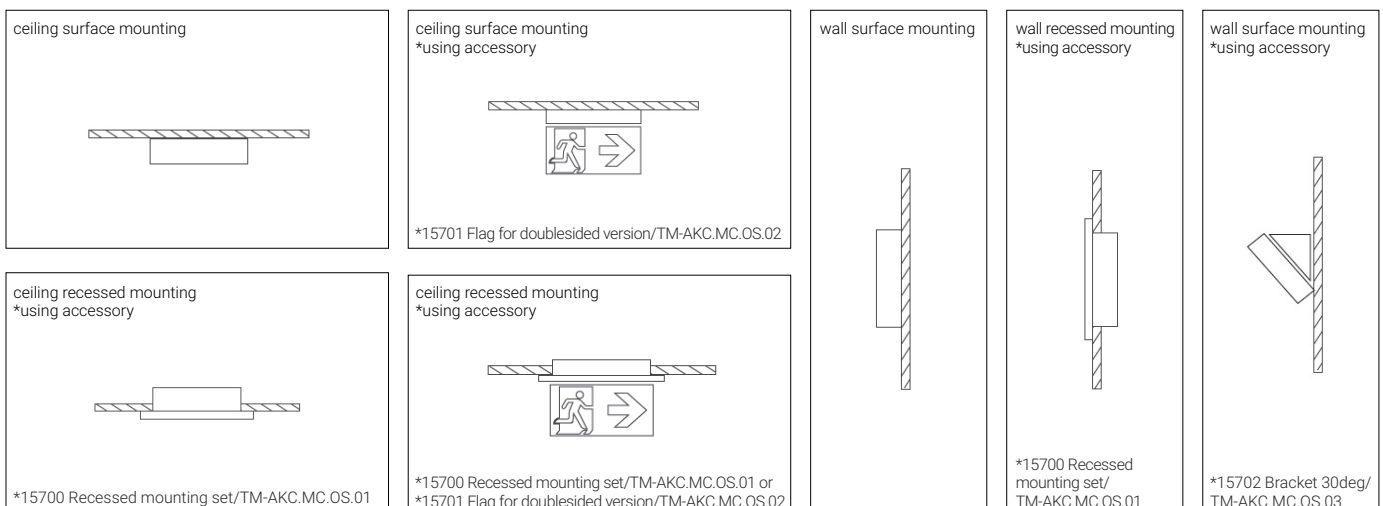
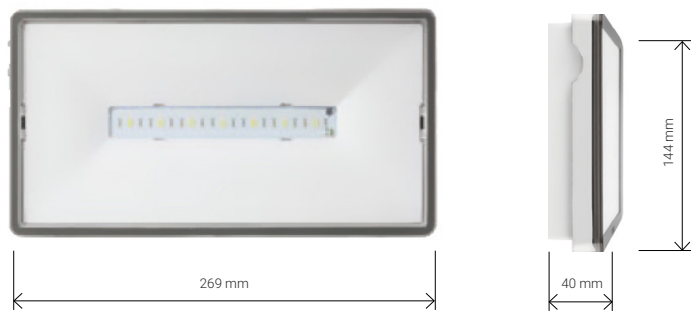

SPECIFICATIONS

Power consumption	1W / 2W / 2.5W
Dimensions	269x144x40mm
Dimensions of pictogram	246x123mm
Housing materials	PC/ABS
Cover materials	PC transparent
Diffuser materials	PMMA
Temperature range ST [°C/F]	10 ÷ 40 / 50 ÷ 104
Temperature range COLD [°C/F]	-15 ÷ 40 / 59 ÷ 104
Temperature range CB [°C/F]	-15 ÷ 55 / 59 ÷ 131
Isolation class	II
Power supply	210 - 250 V AC / 50 - 60HZ
Power supply – CB	186 - 254 V DC
Color temperature [K]	6.000
Housing color	○ RAL 9003
IP Rating	IP65
Mode	M (maintained) / NM (non maintained)
Type of test	ST (manual test)
Warranty [years]	2
Emergency option	EM1H/EM3H

ACCESSORIES

Article Number

15700 Recessed mounting set/TM-AKC.MC.OS.01

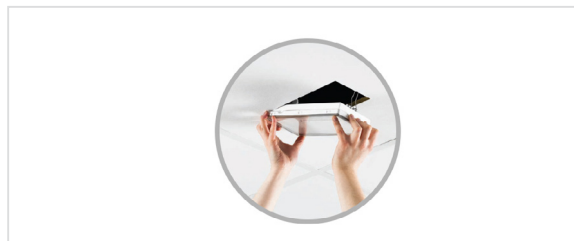

*15701 Flag for doublesided version/TM-AKC.MC.OS.02



15702 Bracket 30deg/TM-AKC.MC.OS.03

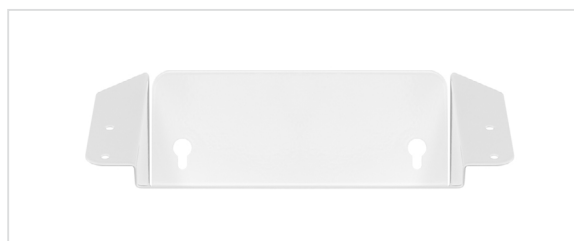

15703 Pictogram/Ontec S/KO-PTMP1

Dimensions

246 mm × 123 mm



15704 Pictogram/Ontec S/KO-PTMP2

Dimensions

246 mm × 123 mm



15707 Pictogram/Ontec S/KO-PTMP5

Dimensions

246 mm × 123 mm



15708 Pictogram/Ontec S/KO-PTMP6

Dimensions

246 mm × 123 mm



ACCESSORIES

Article Number

15709 Pictogram/Ontec S/KO-PTMP7

Dimensions

246 mm × 123 mm



15710 Pictogram/Ontec S/KO-PTMP8

Dimensions

246 mm × 123 mm



15711 Pictogram/Ontec S/KO-PTMP9

Dimensions

246 mm × 123 mm



15712 Pictogram/Ontec S/KO-PTMP10

Dimensions

246 mm × 123 mm



15713 Pictogram/Ontec S/KO-PTMP11

Dimensions

246 mm × 123 mm



15714 Pictogram/Ontec S/KO-PTMP12

Dimensions

246 mm × 123 mm



15715 Pictogram/Ontec S/KO-PTMP13

Dimensions

246 mm × 123 mm



ACCESSORIES

Article Number

15716 Pictogram/Ontec S/KO-PTMP14

Dimensions

246 mm × 123 mm



15717 Pictogram/Ontec S/KO-PTMP15

Dimensions

246 mm × 123 mm



15718 Pictogram/Ontec S/KO-PTMP16

Dimensions

246 mm × 123 mm



15719 Pictogram/Ontec S/KO-PTMP17

Dimensions

246 mm × 123 mm



15720 Pictogram/Ontec S/KO-PTMP18

Dimensions

246 mm × 123 mm

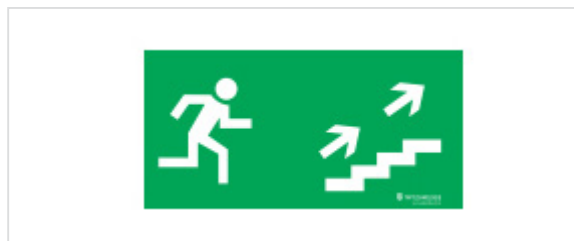

15721 Pictogram/Ontec S/KO-PTMP19

Dimensions

246 mm × 123 mm

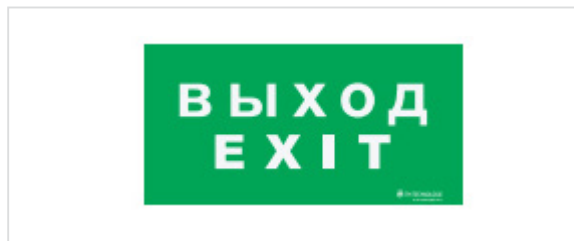

15722 Pictogram/Ontec S/KO-PTMP20

Dimensions

246 mm × 123 mm



ACCESSORIES

Article Number

15723 Pictogram/Ontec S/KO-PTMP21

Dimensions

246 mm × 123 mm

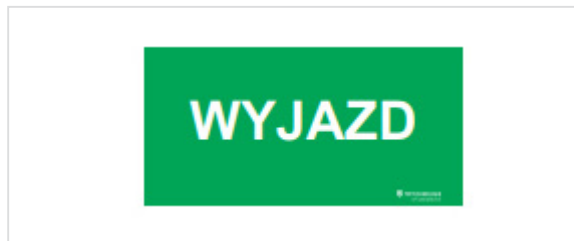

15724 Pictogram/Ontec S/KO-PTMP22

Dimensions

246 mm × 123 mm



15725 Pictogram/Ontec S/KO-PTMP23

Dimensions

246 mm × 123 mm



SPECIFICATIONS

Product	Dimensions (mm)	CCT (K)	Luminance (cd/m ²)	Power (W)	EM Options	Maintained/ Non Maintained	Type of test or destiny	Weight (Kg)
157100 ERD/SM/ONTEC S M2 102 ST/M/NM/6000/2W/1H	269x144x40	6000	>200	2	1H	M/NM	ST	0.532
157101 ERD/SM/ONTEC S M2 302 ST/M/NM/6000/2W/3H	269x144x40	6000	>200	2	3H	M/NM	ST	0.610
157102 ERD/SM/ONTEC S M2 102 COLD ST/M/NM/6000/2W/1H	269x144x40	6000	>200	2	1H	M/NM	ST	0.477
157103 ERD/SM/ONTEC S M2 302 COLD ST/M/NM/6000/2W/3H	269x144x40	6000	>200	2	3H	M/NM	ST	0.656
157104 ERD/SM/ONTEC S E1P 101 ST/M/NM/6000/2.5W/1H	269x144x40	6000	>200	2.5	1H	M/NM	ST	0.593
157105 ERD/SM/ONTEC S E1P 301 ST/M/NM/6000/2.5W/3H	269x144x40	6000	>200	2.5	3H	M/NM	ST	0.593
157106 ERD/SM/ONTEC S E1P 101 COLD ST/M/NM/6000/2.5W/1H	269x144x40	6000	>200	2.5	1H	M/NM	ST	0.538
157107 ERD/SM/ONTEC S E1P 301 COLD ST/M/NM/6000/2.5W/3H	269x144x40	6000	>200	2.5	3H	M/NM	ST	0.619
157108 ERD/SM/ONTEC S M1 01 Cbm/CB/6000/1W	269x144x40	6000	>120	1	-	CB	CB	0.384
157109 ERD/SM/ONTEC S M2 02 Cbm/CB/6000/2W	269x144x40	6000	>200	2	-	CB	CB	0.384
157110 ERD/SM/ONTEC S E1P 01 Cbm/CB/6000/2,5W	269x144x40	6000	>200	2.5	-	CB	CB	0.384