

Installation guide - Montageanleitung Guide d'installation - Ghid de instalare

Kaypro AL, Kaypro AL PA - Surface Mounted

TEC Series / DALI Series / TEC EM Series / DALI EM Series



ATTENTION / ACHTUNG / ATTENTION / ATENȚIE

EN Installation guide

1. Turn power off before inspection, installation or removal.
2. Properly ground electrical enclosure.
3. Follow all IEC and local building codes.
4. Do not operate luminaire with damaged parts.
5. Please see technical data sheet for electrical properties to ensure safe installation.
6. The grounding and bonding of the overall system shall be done in accordance to local electric code of the country where the luminaire is installed.
7. For indoor use, only.
8. Installation should be performed by a qualified electrician in compliance with these instructions and applicable standards.
9. Do not cover the front or rear of the luminaire.

DE Montageanleitung

1. Schalten Sie die Stromversorgung vor der Überprüfung, Montage oder Demontage aus.
2. Stellen Sie sicher, dass die elektrische Verbindung ordnungsgemäß geerdet ist.
3. Befolgen Sie die IEC-Norm und alle lokalen Bauvorschriften.
4. Betreiben Sie die Leuchte nicht mit beschädigten Teilen.
5. Informationen zu elektrischen Eigenschaften finden Sie im technischen Datenblatt, um eine sichere Montage zu gewährleisten.
6. Der Erdanschluss und Verbindung des Gesamtsystems muss gemäß den lokalen Vorschriften in dem Land, in dem die Leuchte montiert wird, erfolgen.
7. Nur für den Innenbereich.
8. Die Montage sollte von einem qualifizierten Elektriker gemäß den vorliegenden Anleitungen und geltenden Normen durchgeführt werden.
9. Decken Sie nicht die Vorder- oder Rückseite der Leuchte ab.

FR Guide d'installation

1. Coupez l'alimentation avant l'inspection, l'installation ou la désinstallation.
2. Reliez correctement le boîtier électrique à la terre.
3. Respectez toutes les normes IEC et locales en vigueur.
4. Ne faites pas fonctionner le luminaire si l'un de ses composants est endommagé.
5. Veuillez consulter la fiche des caractéristiques techniques pour les propriétés électriques afin d'assurer une installation sécuritaire.
6. La mise à la masse et la mise en continuité du système complet doivent être réalisées conformément au code local de l'électricité du pays où le luminaire est installé.
7. Réservé à l'utilisation en intérieur.
8. Il est conseillé de confier l'installation à un électricien qualifié qui devra se conformer aux instructions et aux normes concernant les installations.
9. Ne pas couvrir l'avant ou l'arrière du luminaire.

RO Ghid de instalare

1. Oprîți alimentarea cu energie electrică înainte de a efectua orice operație de verificare, instalare sau dezinstalare.
2. Efectuați corect conexiunea la nulul de protecție al instalației electrice.
3. Respectați directiva IEC și toate directivele locale.
4. Nu folosiți corpul de iluminat dacă prezintă componente deteriorate.
5. Pentru a asigura instalarea în siguranță, consultați fișa tehnică cu proprietățile instalației electrice.
6. Legarea la nulul de protecție și conectarea întregului sistem trebuie efectuate conform normelor locale privind instalațiile electrice din țara în care se montează corpul de iluminat.
7. Doar pentru uz interior.
8. Instalarea trebuie realizată de către un electrician calificat, în concordanță cu instrucțiunile și standardale aplicabile.
9. Nu acoperiți partea din față sau din spate a corpului de iluminat.

Kaypro - Surface Mounted

Kaypro PA - Surface Mounted

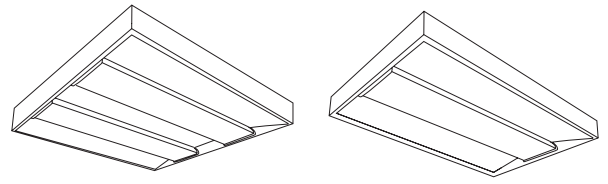
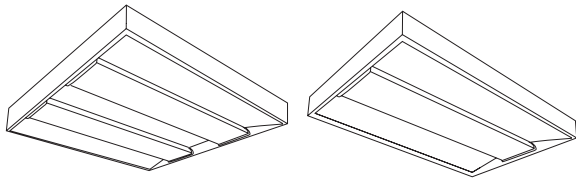

1.

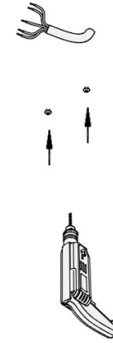
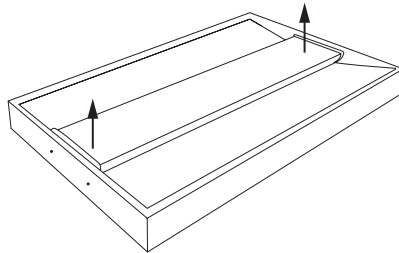
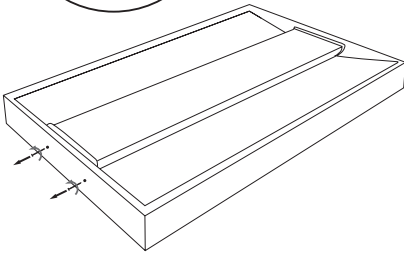
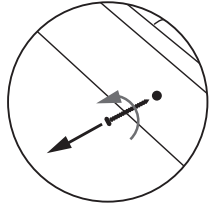

Place the holes in the ceiling according to the template in 2.
 Placez les trous dans le plafond selon le modèle de 2.
 Platziere die Löcher in der Decke gemäß der Vorlage in 2.
 Se dau gaurile in tavan conform sablonului de la pct. 2.

2. template / modèle / schablone / sablon

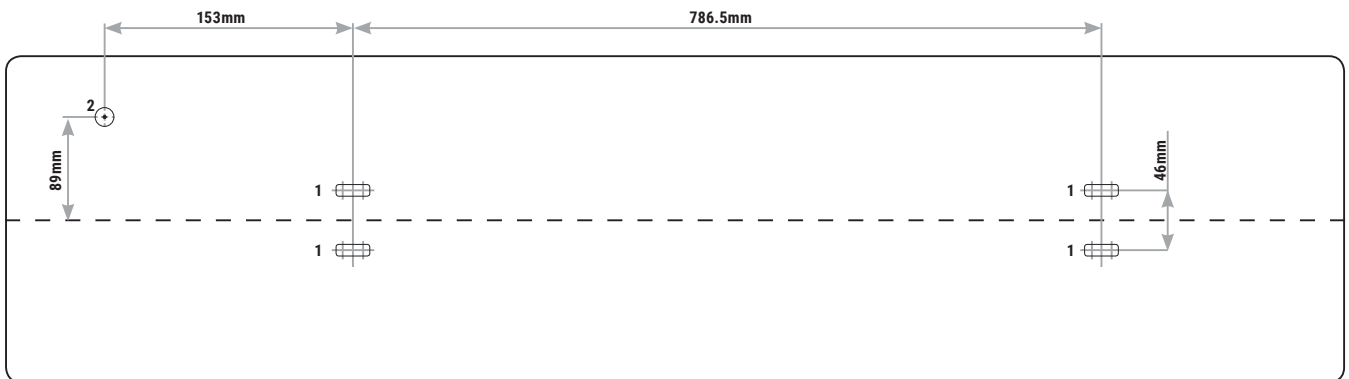

- 1. mounting holes / trous de montage / Befestigungslöcher / gauri de montaj
- 2. power cord / cordon d'alimentation / Netzkabel / cablului de alimentare

3.a

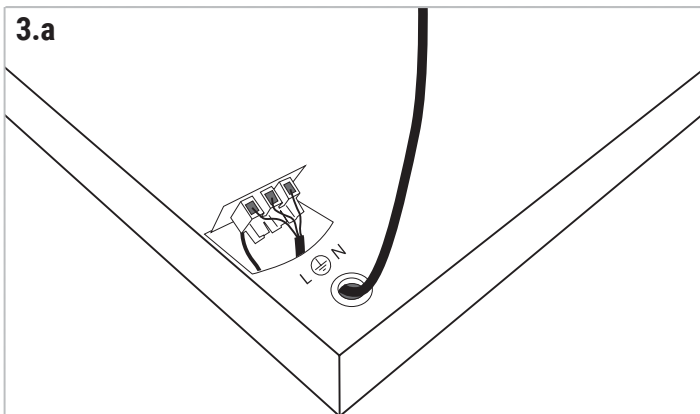

For TEC Series
 Pour la série TEC
 Für TEC-Serie
 Pentru seria TEC

3.b

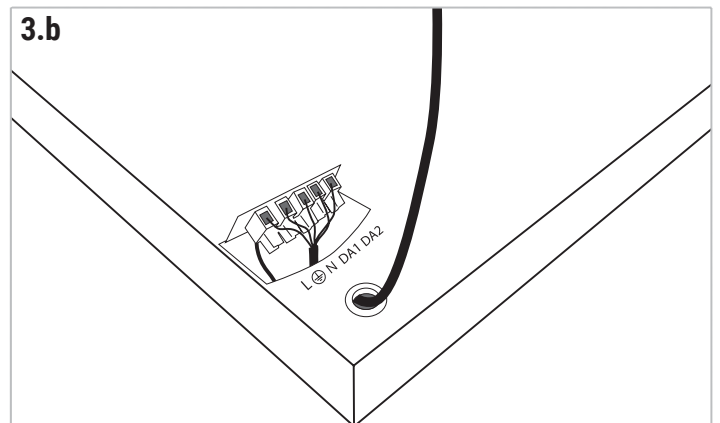

For DALI Series
 Pour la série DALI
 Für DALI Serie
 Pentru seria DALI

3.c

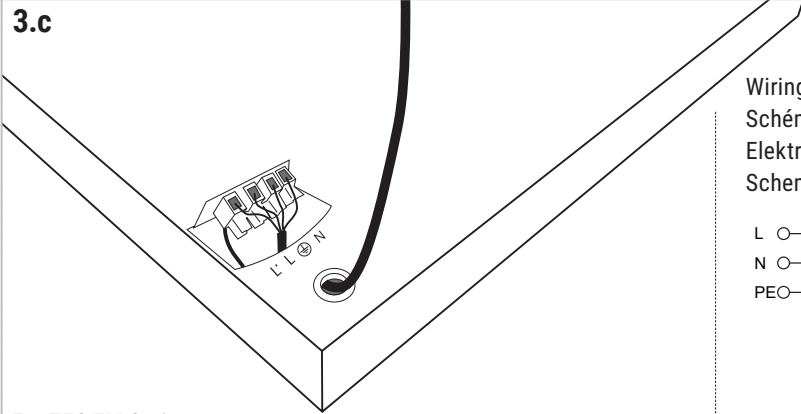

For TEC EM Series
 Pour la série TEC EM
 Für TEC EM-Serie
 Pentru seria TEC EM

Wiring diagram
 Schéma électrique
 Elektrisches Schema
 Schemă electrică

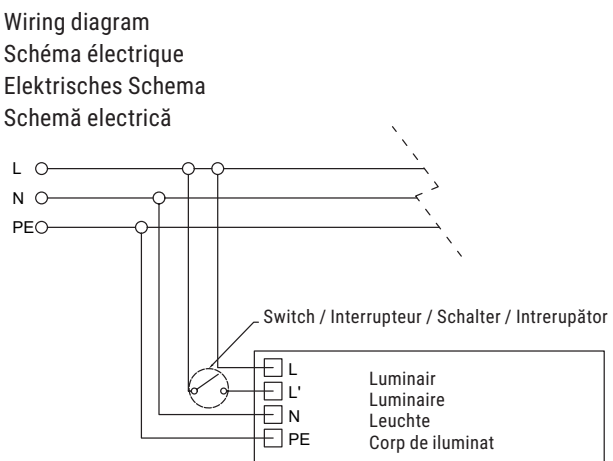

Switch / Interrupteur / Schalter / Intrerupător

L	Luminair
L'	Luminaire
N	Leuchte
PE	Corp de iluminat

3.d

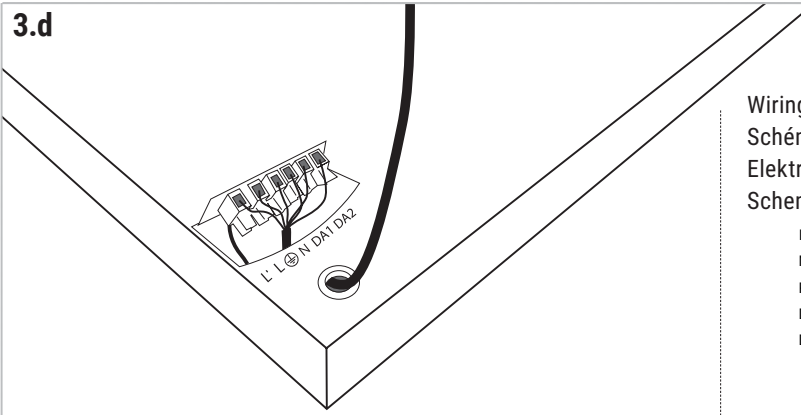

For DALI EM Series
 Pour la série DALI EM
 Für DALI EM-Serie
 Pentru seria DALI EM

Wiring diagram
 Schéma électrique
 Elektrisches Schema
 Schemă electrică

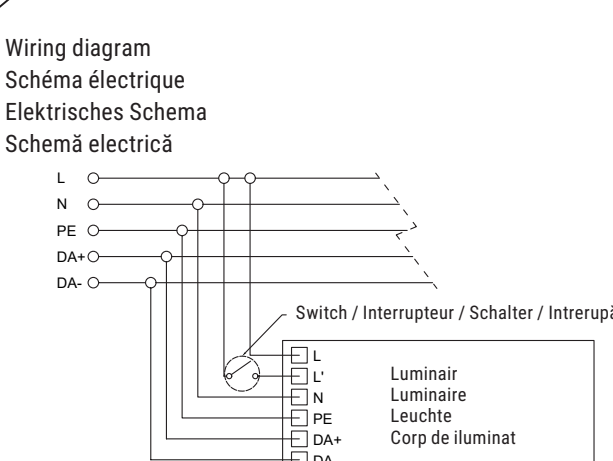

Switch / Interrupteur / Schalter / Intrerupător

L	Luminair
L'	Luminaire
N	Leuchte
PE	Corp de iluminat
DA+	
DA-	

4.

